



**AMERICAN SECURITY**

EST 1946



2024

# Gun Safe Catalog

# Table of Contents

<b>RF Series TL-30 and TL-30X6</b> .....	<b>5</b>
<b>BFI Series</b> .....	<b>6</b>
<b>BFX Series</b> .....	<b>7</b>
<b>NF Series</b> .....	<b>12</b>
<b>SF Series</b> .....	<b>13</b>
<b>TF Series</b> .....	<b>14</b>
<b>AM Series</b> .....	<b>15</b>
<b>Jewelry Safe</b> .....	<b>16</b>
<b>FS Series and EST Series</b> .....	<b>17</b>
<b>Concealed Safe and Handgun Series</b> .....	<b>18</b>
<b>Vault Door Series</b> .....	<b>19</b>
<b>Storage Options and Safe Cloak</b> .....	<b>20</b>
<b>Locks and Other Options</b> .....	<b>21</b>
<b>Gun Safes At A Glance</b> .....	<b>22</b>



# WE STAND BEHIND OUR CRAFTSMANSHIP WITH A "NO COST" LIFETIME WARRANTY AGAINST THEFT & FIRE



American Security® manufactures safes with the best fire and burglary protection in the industry. We're so confident in our products, that we offer a lifetime warranty on all our gun safes. Our warranty covers:

- Burglaries – If your safe is forcibly entered, we will repair or replace it free of charge.
- Attempted Burglaries – If your safe undergoes a drill, punch or pry attack and is not breached, we will repair or replace it free of charge.
- Damage from a Home Fire – If your safe is damaged in a home fire, we will repair or replace it free of charge.

At no cost to you, we will either repair your damaged gun safe or replace it with a current production model of comparable value.<sup>1</sup>



**Intertek**

## STANDARDIZED TESTING FROM INDEPENDENT LABORATORIES

American Security is one of the first manufacturers in the gun safe industry to use standardized test procedures from independent laboratories to substantiate our burglary and fire ratings. Standardized independent testing provides consistent test procedures that can be used across the industry so consumers can meaningfully compare ratings between different safes when making a purchasing decision.

### BURGLARY RATINGS

In the United States, the most recognized testing organization for burglary resistance of safes is Underwriters Laboratories (UL). UL publishes standards and administers tests to check if products meet those standards. Standards include specific tools that are used during a break-in attempt and a specific time limit for the test. There are several different burglary classifications that establish specific levels of attack resistance. The most common listing in the gun safe industry is Residential Security Container (RSC).

### FIRE RATINGS

The ETL logo on our fire-rating labels indicates that our ratings have been verified by independent testing at Intertek Laboratories. Intertek is a multinational independent inspection, product testing and certification organization with over 38,000 employees in over 100 countries. To test our products, Intertek places our safes in a furnace with 8 gas burners. The test furnaces reach 1200°F in 8 minutes. That temperature is maintained for the duration of the test. Five separate thermocouples monitor the temperature inside the safe. To pass Intertek's test, the internal temperature inside a safe must remain below 350°F. Paper burns at approximately 450°F.

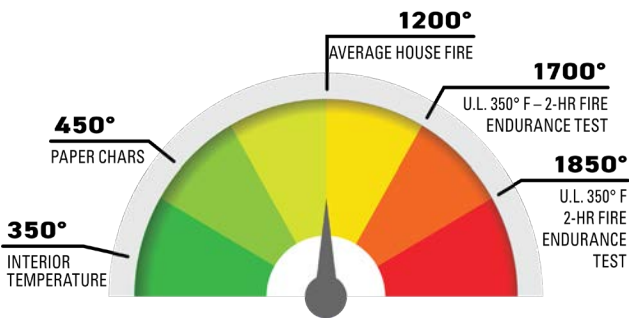

Series	Fire Label	Outside Temp	Time Period	Inside Temp Less Than
RF Series	120	1800°F	120 min.	350°F
BFI / BFX Series	ETL 120	1200°F	120 min.	350°F
NF Series	ETL 90	1200°F	90 min.	350°F
SF Series	ETL 60	1200°F	60 min.	350°F
TF Series	30	1200°F	30 min.	350°F

<sup>1</sup>To file a claim, you must be the original owner of the American Security Gun Safe. Within 30 days of the burglary/fire incident, you must properly file a police report documenting the incident. A copy of the police report must be submitted to American Security with your warranty claim.

# RF Series (TL-30 and TL-30x6)

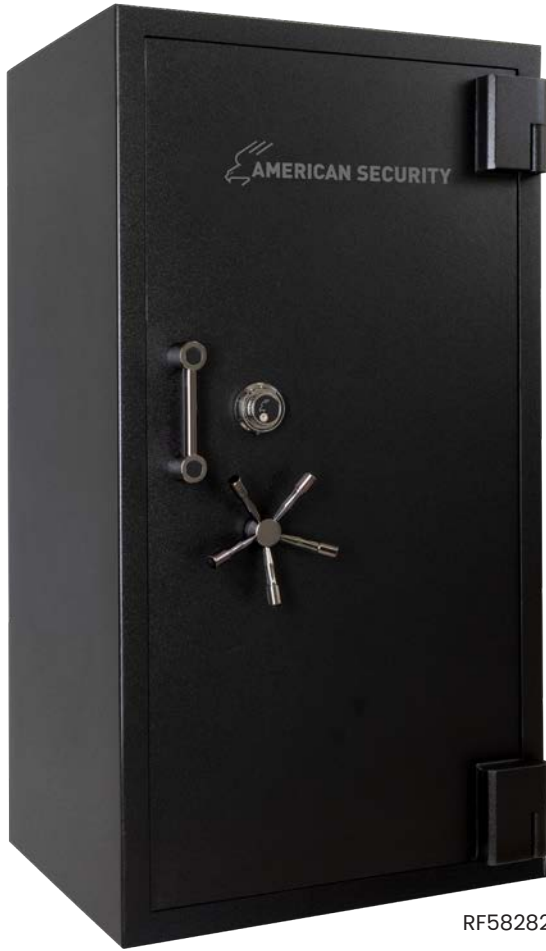

RF582820X6

## FEATURES

- The highest security rated gun safe on the market! Simply the best!
- The only TL-30x6 gun safe on the market
- Made in the USA

## SECURITY

- 6" thick high security composite door
- UL Listed TL-30 (RF6528) or TL-30x6 (RF703620X6 and RF582820X6) high security burglary classification
- Active 3-way bolt work
- 10 massive 1½" chrome plated bolts
- Anchor holes provided

## WARRANTY

- 5-year parts and labor warranty when purchased with a factory installed American Security lock
- Special lifetime warranty for damage from burglary attempts and fire

## FIRE PROTECTION

- Palusol seals to protect against fire and smoke
- Fire protection of 1850°F for 120 minutes

## FUNCTIONALITY

- Storage for long guns
- Door organizer and light kit providing excellent high valuable storage solutions for both guns and other personal items
- 3-outlet/USB power strip
- Industry's most flexible interior



## TEXTURED

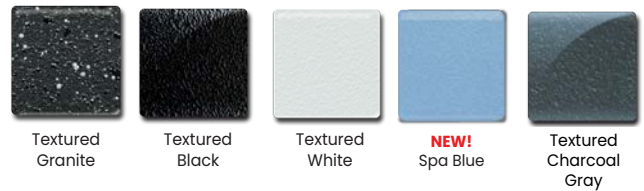

## HARDWARE

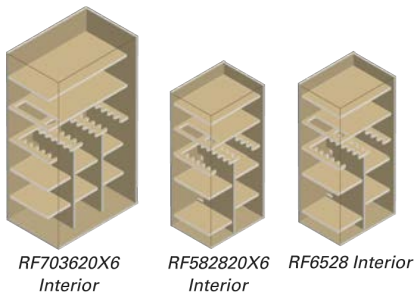

Model	Outside Dimension H x W x D	Door Clearance H x W	Body Thickness	Interior Capacity	Weight	Lock Type
RF703620X6	76" x 42" x 29¼"	70" x 36"	3"	12-12-12-24-36+2 Gun or 58 + 2 Gun	4,578 lbs.	See pg. 23
RF582820X6	64" x 34" x 29¼"	58" x 28"	3"	12-12-24 + 2 Gun	3,455 lbs.	See pg. 23
RF6528	72" x 35" x 29¼"	65" x 28"	3½"	12-12-24 + 2 Gun	3,418 lbs.	See pg. 23

# BFII Series



BFII6032

## FEATURES

- Made in the USA

## SECURITY

- The only UL RSC II security rated gun safe on the market! Double the security rating of all other gun safe brands on the market.
- ½" steel plate door offering a substantial solid steel security barrier against aggressive attacks
- Double the steel protection in the body with an 11GA outer steel barrier and a ⅝" inner steel liner
- TL-15 boltwork with 10 massive 1½" chrome plated bolts
- Our patented active hardplate that is typically only found on our TL security rated safes
- Anchor holes provided

## WARRANTY

- 5-year parts and labor warranty when purchased with a factory installed American Security lock
- Special lifetime warranty for damage from burglary attempts and fire

## FIRE PROTECTION

- DryLight® fill – American Security's proprietary seamless, lightweight, high performance fire barrier
- ETL fire rating of 1200°F for 120 minutes
- Dual door seals to protect against fire and smoke

## FUNCTIONALITY

- Industry's most flexible interior
- Door organizer
- Storage for long guns on door
- 3-outlet/USB power strip
- LED light kit
- Power strip

## BFII SERIES CONSTRUCTION

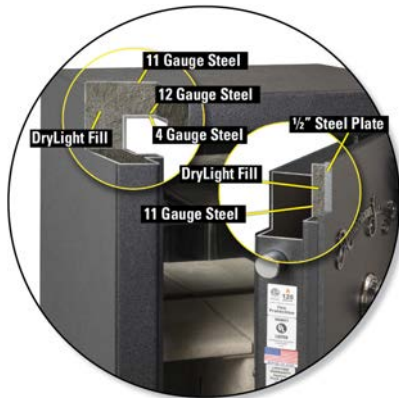

### BFII GUN SAFES:

⅝" OUTER STEEL LINER WITH ⅝" INNER STEEL LINER PROVIDING A NEAR TOTAL ½" THICK STEEL BARRIER FOR ADDED BURGLARY PROTECTION



Model	Outside Dimension H x W x D	Door Clearance H x W	Body Thickness	Interior Capacity	Weight	Lock Type
BFII7250	71¼" x 50" x 28"	63¾" x 42⅝"	2¼"	14-14-14-28-42 + 2 Gun or 73 + 2 Gun	2,438 lbs.	See pg. 23
BFII7240	71¼" x 40" x 26"	63¾" x 32⅝"	2¼"	12-12-12-24-36 + 2 Gun or 58 + 2 Gun	1,991 lbs.	See pg. 23
BFII6636	65¼" x 36" x 26"	57¾" x 28⅝"	2¼"	12-12-24 + 2 Gun	1,716 lbs.	See pg. 23
BFII6030	59¼" x 30" x 26"	51¾" x 22⅝"	2¼"	11-11-22 + 2 Gun	1,395 lbs.	See pg. 23
BFII6032	59¼" x 30" x 21"	51¾" x 16⅝"	2¼"	9-9-18 + 2 Gun	1,244 lbs.	See pg. 23
BFII6024	59¼" x 24" x 21"	51¾" x 16⅝"	2¼"	8-8-16 Gun + 1 Gun	1,067 lbs.	See pg. 23

# BFX Series



BFX6036

## FEATURES

- Made in the USA

## SECURITY

- UL RSC I security rating
- 1/2" steel plate door (3/8" on 7240 & 7250) providing a substantial solid steel barrier against aggressive attacks
- Double the steel protection in the body with an 11GA outer steel barrier and a 12GA inner steel liner
- Active 4x locking system:
- 1/4" hardplate and a top-rated hardened disc defeats lock attacks
- Spring loaded relock mechanism
- Gear cam housing with precision engineered lock bolt protection
- 4-way active bolt work (BFX6024 has 2-way bolt work)
- 10, 14, and 16 massive 1 1/2" chrome plated bolts
- Anchor holes provided

## WARRANTY

- 5-year parts and labor warranty when purchased with a factory installed American Security lock

- Special lifetime warranty for damage from burglary attempts and fire

## FIRE PROTECTION

- DryLight® fill - American Security's proprietary seamless, lightweight, high performance fire barrier
- ETL fire rating of 1200°F at 120 minutes
- Dual door seals to protect against fire and smoke

## FUNCTIONALITY

- Industry's most flexible interior
- Door organizer
- Storage for long guns on door
- 3-outlet/USB power strip
- LED light kit
- Power strip

## BFX SERIES CONSTRUCTION

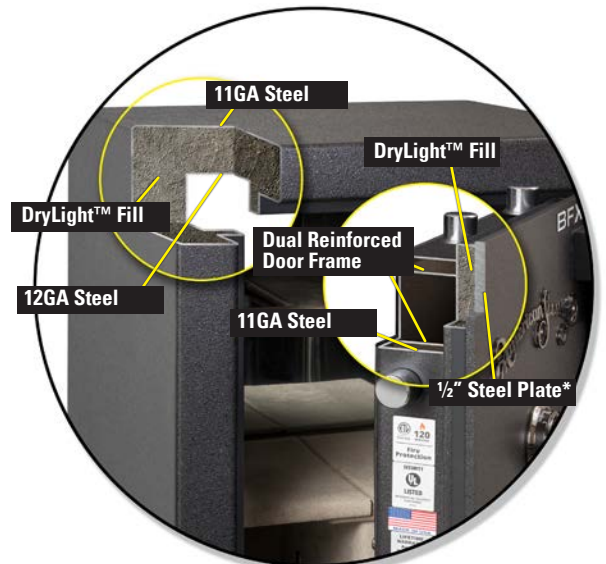

**BFX GUN SAFES:  
11GA OUTER STEEL LINER WITH  
12GA INNER STEEL LINER  
TOTALING APPROX. 1/4" STEEL BARRIER**

\*3/8" Plate on BFX7250 and BFX6024

# BFX Series *(continued)*



BFX6032



Model	Outside Dimension H x W x D	Door Clearance H x W	Body Thickness	Interior Capacity	Weight	Lock Type
BFX7250	71¼" x 50" x 28"	63¾" x 42½"	2"	14-14-14-28-42 + 2 Gun or 73 + 2 Gun	1,789 lbs.	See pg. 23
BFX7240	71¼" x 40" x 26"	63¾" x 32½"	2"	12-12-12-24-36 + 2 Gun or 58 + 2 Gun	1,585 lbs.	See pg. 23
BFX6636	65¼" x 36" x 26"	57¾" x 28½"	2"	12-12-24 + 2 Gun	1,319 lbs.	See pg. 23
BFX6030	59¼" x 30" x 26"	51¾" x 22½"	2"	11-11-22 + 2 Gun	1,036 lbs.	See pg. 23
BFX6032	59¼" x 30" x 21"	51¾" x 22½"	2"	9-9-18 + 2 Gun	913 lbs.	See pg. 23
BFX6024	59¼" x 24" x 21"	51¾" x 16½"	2"	8-8-16 Gun + 1 Gun	720 lbs.	See pg. 23



# BFX Series (continued)

## ACTIVE 4X LOCKING SYSTEM

BUILT WITH UNBEATABLE SECURITY FEATURES THAT KEEP BURGLARS OUT!

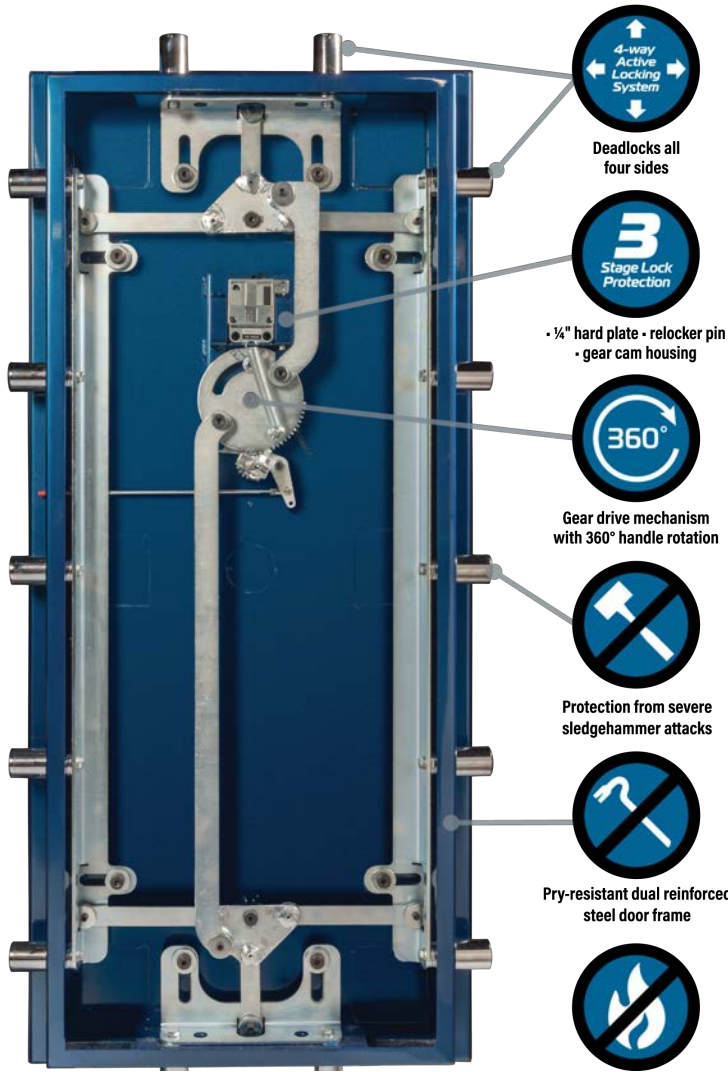

Deadlocks all four sides



• ¼" hard plate - relocker pin  
• gear cam housing



Gear drive mechanism with 360° handle rotation



Protection from severe sledgehammer attacks



Pry-resistant dual reinforced steel door frame



### DRILL ATTACK PROTECTION

- ¼" hardplate and a top-rated hardened disc defeats lock attacks
- Spring loaded relock mechanism
- Gear cam housing with precision engineered lock bolt protection

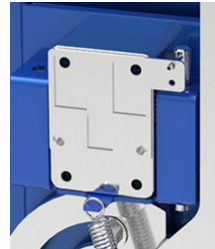

### GEAR-DRIVEN BOLTWORK WITH 360° HANDLE ROTATION

Drives the industry's longest solid steel locking bolts deep into the body of the safe protecting the safe against severe pry attacks.



### PRY-RESISTANT DUAL REINFORCED STEEL DOOR FRAME

Protects the heart of the Active 4x locking mechanism from severe pry attacks.



### SLEDGEHAMMER IMPACT-RESISTANT BOLTWORK

Protects the heart of the Active 4x locking mechanism from severe sledgehammer attacks.

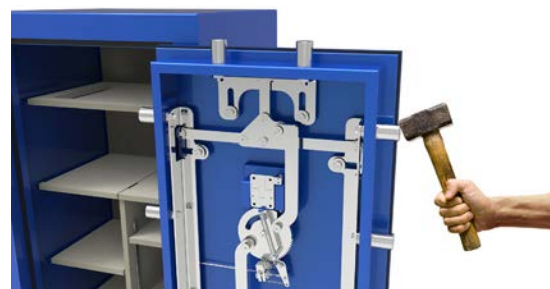

# BFX and BFII Series

## WHAT IS DRYLIGHT®?



The American Security® BF® Gun Safes are the best gun safe available today. For burglary protection, it has a massive ½"-thick steel plate in the door. For fire protection, it is filled with our revolutionary DryLight.

For many years, smaller fire safes have been constructed with a poured fill material. But larger gun safes pose several manufacturing challenges when it comes time to fill them with insulating materials. Because of this, the industry adopted the use of drywall as the primary material for fire protection. The problem with using drywall is that no matter how much care is taken in assembling the many pieces of drywall into the safe body, gaps and joints still remain in the construction that can allow heat to penetrate the safe body. American Security was able to overcome this technical challenge by developing manufacturing processes that allow us to produce a safe body filled with the seamless DryLight fire barrier. Independent testing at Intertek Laboratories has confirmed that these safes outperform gun safe bodies constructed with drywall.

## BFX/BFII BURGLARY RATINGS COMPARISON

BFX Gun Safes - RSC Level I (1-Man, 5 minute test. Utilizes tools typically found in a household)	BFII Gun Safes - RSC Level II (2-man Team, 10 minute test. Utilizes same tools as a TL-15 test)
1/4" Dia. Punch	1/2" Dia. Punch
Sledge Hammer 3 lb.	Sledge Hammer 10 lb.
Crow Bar, 18"	Pry Bar, 6 ft.
Chisel 1/2"	Chisel 1" Wide x 12" L
Screw Driver 18	Screw Driver 18
1/4" Drill Bits	1/2" Drill Bits
3/8" Drill	1/2" HD Drill
	Pick, 30"
	Axe, 35"
	4" Conic Punch
	Hole Saw, 3" Carbide
	Pin Hammer
	Wedge, Log Splitting
	Punch/Chisel Holder

RSC LEVEL I TOOL COMPLEMENT



RSC LEVEL II TOOL COMPLEMENT



# BFX and BFII Series (continued)

## COLOR OPTIONS AND INTERIOR OPTIONS



**BFII6030** Shown in Onyx Gloss with Chrome Hardware, ESL10 and logo



**BFX6636** Shown in Sapphire Blue Gloss with Chrome Hardware, ESL10 and logo, and optional finials



**BFX6032** Shown in Pearl Essence Gloss with Black Nickel Hardware, ESL10 and logo, and optional finials

### HIGH GLOSS

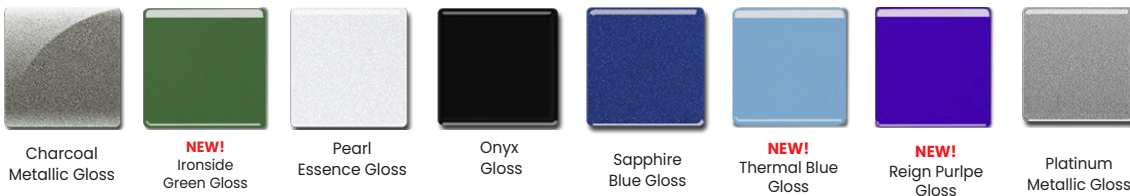

### TEXTURED

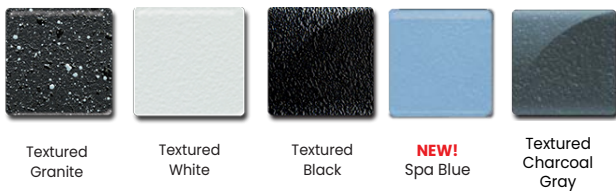

### HARDWARE



\*Two-tone combinations available with textured body, using any standard textured color, and either high gloss or textured door. Please refer to Standard Colors list.

\*\* Quotes available for other custom options such as two-tone high gloss, discontinued colors, or color match to your specifications, subject to manufacturing limitations.

### BFX/BFII INTERIOR CONFIGURATIONS

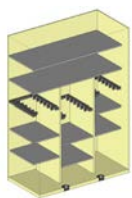

7250 Standard Gun Interior

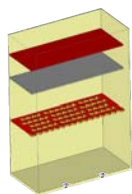

7250 Optional 73 Gun Interior

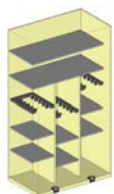

7240 Standard Gun Interior

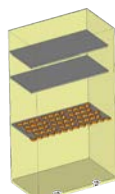

7240 Optional 58 Gun Interior

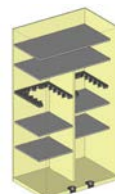

6636 Standard Gun Interior

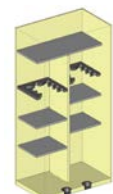

6030 Optional Gun Interior

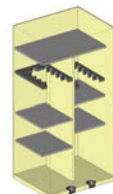

6032 Standard Gun Interior

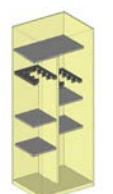

6024 Optional Gun Interior

# NF Series



NF6036

The American Security® NF Gun Safe offers both superior performance and value. For burglary protection, it has a stout ¼"-thick steel plate door. For fire protection, it is lined with three to four layers of fire protection panels that are strategically engineered for optimal fire protection. This enables the NF Gun Safe to pass a verified 90-minute fire test at Intertek, an independent testing laboratory.

## FEATURES

- Lifetime warranty against burglary and fire

## SECURITY

- ¼" solid steel plate door, providing superior protection against pry attacks, along with an 11GA solid steel body.
- 4-way bolt work
- UL RSC I security rating
- 14 massive 1½" chrome plated bolts
- Anchor holes provided
- **NEW:** UL Listed ESL10 electronic lock
- Decorative five-spoke handle

## FIRE PROTECTION

- Lined with 3-4 layers of fire protection panels
- Dual door seals to protect against fire and smoke
- ETL fire rating of 1200°F for 90 minutes

## FUNCTIONALITY

- Industry's most flexible interior
- Door organizer
- Storage for 2 long guns on door (1 on NF5924E5)
- AC power outlet with removable cord
- **NEW:** LED light kit

## NF SERIES CONSTRUCTION

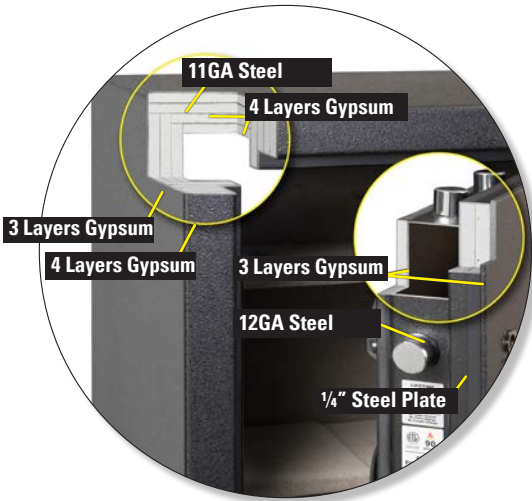

## TEXTURED



Textured  
Gunmetal  
Gray

## HARDWARE



Black Nickel

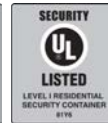

NF5924  
Interior

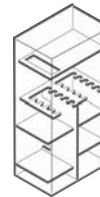

NF6032  
Interior



NF6030  
Interior

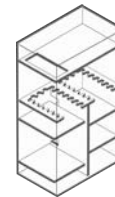

NF6036  
Interior

Model	Outside Dimension H x W x D	Door Clearance H x W	Body Thickness	Interior Capacity	Weight	Lock Type
NF6036	59" x 36" x 26"	52" x 28¾"	2¾"	17-17-34 + 2 Gun	977 lbs.	ESL10
NF6030	59" x 30" x 26"	52" x 22¾"	2¾"	14-14-28 + 2 Gun	788 lbs.	ESL10
NF6032	59" x 30" x 21"	52" x 22¾"	2¾"	9-9-18 + 2 Gun	761 lbs.	ESL10
NF5924	59" x 24" x 18"	52" x 16¾"	2¾"	8-8-16 Gun + 1 Gun	600 lbs.	ESL10

# SF Series



SF6032

The American Security® SF gun safe offers both performance and value. For burglary protection, it has a stout  $\frac{3}{16}$ "-thick steel plate door. For fire protection, it is lined with three to four layers of fire protection panels that are strategically engineered for optimal fire protection. This enables the SF Gun Safe to pass a verified 60-minute fire test at Intertek, an independent testing laboratory.

#### FEATURES

- Lifetime warranty against burglary and fire

#### SECURITY

- $\frac{3}{16}$ " solid steel plate door providing superior protection against pry attacks
- 12GA solid steel body lined with 3-4 layers of fire protection panels providing respectable burglary and fire protection
- 4-way bolt work offering an extra layer of security on all 4 sides of the door
- 14 massive  $\frac{1}{4}$ " chrome plated bolts
- Anchor holes provided
- Decorative 3-spoke handle

#### FIRE PROTECTION

- Dual door seals to protect against fire and smoke
- ETL fire rating of 1200°F for 60 minutes

#### FUNCTIONALITY

- UL Listed ESL5 electronic lock with illuminated keypad
- Industry's most flexible interior
- Door organizer
- Storage for 2 long guns on door
- **NEW:** LED light kit

### SF SERIES CONSTRUCTION

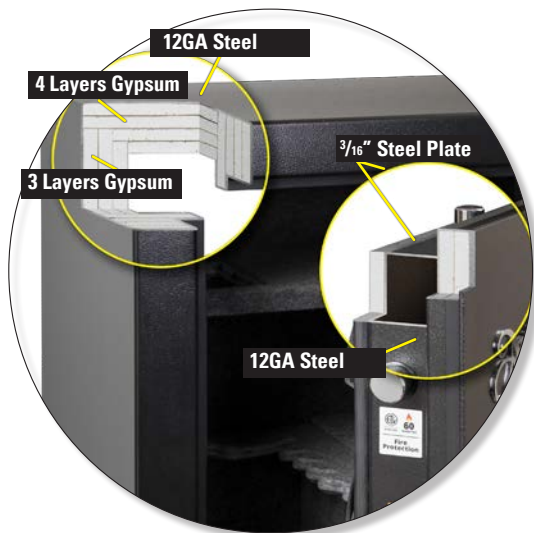

#### TEXTURED



Textured Black

#### HARDWARE



Black Nickel

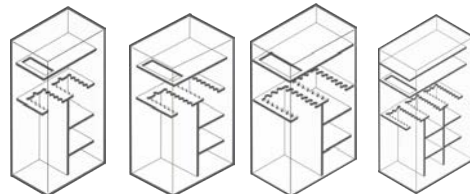

SF6032 Interior

SF6030 Interior

SF6036 Interior

SF7240 Interior

Model	Outside Dimension H x W x D	Door Clearance H x W	Body Thickness	Interior Capacity	Weight	Lock Type
SF7240	72" x 40" x 26"	63½" x 31½"	2"	15-15-15-30-45 + 2 Gun	1,086 lbs.	ESL5
SF6036	59" x 36" x 26"	50½" x 27½"	2"	17-17-34 + 2 Gun	840 lbs.	ESL5
SF6030	59" x 30" x 26"	50½" x 21½"	2"	15-15-30 + 2 Gun	748 lbs.	ESL5
SF6032	59" x 30" x 21"	50½" x 21½"	2"	9-9-18 + 2 Gun	662 lbs.	ESL5

# TF Series



TF5924E5

The American Security® TF Gun Safe offers economic trusted protection. For burglary protection, it has a stout  $\frac{3}{16}$ "-thick steel plate door. For fire protection, it is lined with fire protection panels that are strategically engineered for 30 minutes of fire protection.

## FEATURES

- An economical gun safe offering impressive features!
- Lifetime warranty against burglary and fire

## SECURITY

- $\frac{3}{16}$ " solid steel plate door, providing superior protection against pry attacks
- 4-way bolt work offering an extra layer of security on all 4 sides of the door
- 14GA solid steel body lined with 1-2 layers of fire protection panels providing burglary and fire protection
- (14)  $\frac{1}{4}$ " chrome plated bolts on TF5924E5
- (8) 1" chrome plated bolts on TF5517E5
- Anchor holes provided
- UL Listed ESL5 electronic lock with illuminated keypad

## FIRE PROTECTION

- Lined with 2 layers of fire protection panels on the ceiling and door
- Lined with 1 layer of fire protection panels in all the walls
- Dual door seals to protect against fire and smoke
- Fire rating of 1200°F for 30 minutes

## FUNCTIONALITY

- Decorative 3-spoke handle on TF5942E5, "L" style handle on TF5517E5.
- Industry's most flexible interior
- Door organizer
- TF5924 has storage for 1 long gun on the door

## TEXTURED



Textured Black

## HARDWARE



Black Nickel

## TF SERIES CONSTRUCTION

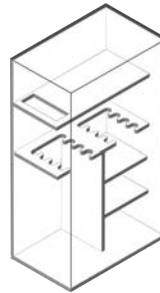
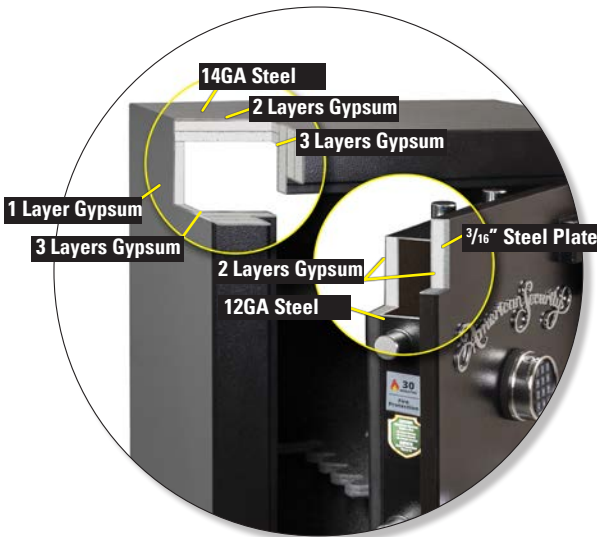

TF5924 Interior



TF5517 Interior

Model	Outside Dimension H x W x D	Door Clearance H x W	Body Thickness	Interior Capacity	Weight	Lock Type
TF5924	59" x 24" x 18"	52" x 16 $\frac{3}{4}$ "	1"	8-8-16 Gun + 1 Gun	388 lbs.	ESL5
TF5517	55 $\frac{1}{4}$ " x 17 $\frac{3}{4}$ " x 16"	49 $\frac{1}{2}$ " x 12"	1"	11 Gun	286 lbs.	ESL5

# AM Series



AM2020E5



AM3020E5



AM4020E5

## FEATURES:

- 3/16" solid steel plate door, providing superior protection against pry attacks
- Powder-coated blue with black nickel hardware
- Gray fabric interior
- Backlit UL Listed ESL5 electronic lock with stealth mode keypad
- 12GA steel body
- Lined with fire protection panels
- ETL fire rating of 1200°F for 45 minutes
- 3-way bolt work
- 4 pre-cut anchor holes
- AM2020E5: 1 shelf
- AM3020E5: 2 shelves
- AM4020E5: 3 shelves

## TEXTURED



Textured  
AM Blue

## HARDWARE



Black Nickel



Model	Outside Dimension H x W x D	Door Clearance H x W	Body Thickness	Interior Capacity	Weight	Lock Type
AM2020E5	20" x 20" x 20"	14½" x 14½"	12GA	3,811 cu. in.	180 lbs.	ESL 5
AM3020E5	30" x 20" x 20"	24½" x 14½"	12GA	6,121 cu. in.	230 lbs.	ESL 5
AM4020E5	40" x 20" x 20"	34½" x 14½"	12GA	8,431 cu. in.	316lbs.	ESL 5

# Jewelry Safe



JS2020E5

## FEATURES:

- 3/16" solid steel plate door, providing superior protection against pry attacks
- Textured white exterior with black nickel hardware
- Quilted faux leather interior
- 2 interior drawers measuring: 9" W x 17/8" H x 113/4" D
- Backlit UL Listed ESL5 electronic lock
- 12GA steel body
- Lined with fire protection panels
- ETL fire rating of 1200°F for 45 minutes
- 3-way bolt work
- 4 pre-cut anchor holes
- LED light kit
- Necklace hangers
- Motion sensor light

## TEXTURED



Textured  
White

## HARDWARE



Black Nickel



Model	Outside Dimension H x W x D	Door Clearance H x W	Body Thickness	Interior Capacity	Weight	Lock Type
JS2020E5	20" x 20" x 20"	14½" x 14½"	12GA	3,811 cu. in.	180 lbs.	ESL 5



# FS Series



FS1814E5

American Security®'s 1-Hour Fire Safes are the only UL Listed 1-hour fire safe offering a UL Listed electronic lock. These locks offer far greater security than the locks offered on any other 1-hour fire safe.

#### FEATURES

- The only safe in its class that comes with back lit keypad making it easier to enter your combination

#### FS914E5LP AND FS149E5LP FEATURES

- The only safe in its class with a UL Listed type 1 ESL5LP electronic lock preventing the safe from being "bounced open".
- 1 drawer shelf
- Handle operated side-locking mechanism with two chromed locking bolts
- 2 deadbolts prevent door removal
- 4 rubber feet
- 1 internal anchor hole and hardware
- UL fire rating of 60 minute

#### FS1814E5 FEATURES

- UL ESL5 electronic lock
- Handle operated locking mechanism with 3-way boltwork
- 2 deadbolts prevent door removal
- 1 key-lock drawer and one adjustable shelf
- 1 internal anchor hole and hardware
- UL fire rating of 60 minute

Model	Outside Dimension H x W x D	Door Clearance H x W	Body Thickness	Interior Capacity	Weight	Lock Type
FS914E5LP	14" x 19½" x 15⅜"	9¾" x 15¼"	2⅞"	1,438 cu. in.	96 lbs.	ESL5LP
FS149E5LP	19½" x 14" x 15⅜"	15¼" x 9¾"	2⅞"	1,468 cu. in.	96 lbs.	ESL5LP
FS1814E5	23¾" x 18⅞" x 18½"*	18¼" x 13⅞"	2¾"	2,964 cu. in.	164 lbs.	ESL5

# EST Series



EST916

#### FEATURES

- DL6000 bounce-proof electronic lock with a large LCD display allows smooth and easy operation
- LCD display shows low-battery indicator, time, date and keypad
- Emergency key-lock override system with 2 keys, power override battery box, built-in spy-proof function and motion detector alert
- Can be bolted to the wall or floor
- Carpeted base
- Pry-resistant recessed door with internal hinges for anti-theft protection
- Anchor hardware standard
- Models EST1014 and EST2014 have 1 removable shelf

Model	Outside Dimension H x W x D	Door Clearance H x W	Body Thickness	Interior Capacity	Weight	Lock Type
EST813	7⅞" x 12¼" x 8"	5¾" x 8¼"	14GA	499 cu. in.	16 lbs.	DL6000
EST916	9" x 16" x 13¼"	6¾" x 12⅞"	14GA	1,550 cu. in.	27 lbs.	DL6000
EST1014	9¾" x 14⅞" x 9¾"	7⅞" x 10¼"	14GA	1,032 cu. in.	22 lbs.	DL6000
EST2014	19¾" x 13¾" x 12¼"	17⅞" x 9¼"	14GA	2,602 cu. in.	40 lbs.	DL6000

# Concealed Safe



UBS648



American Security's UBS648 has been dramatically improved since the development of our original Defense Vault (DV652). Still a secure and easy-to-conceal security container for gun storage, the UBS648 features an ultra slim profile just six inches tall, able to fit under most beds or the back of an SUV. Four mounting holes on both the top and the bottom of the unit make it possible to secure it to the floor, or undermount it to your bed frame or other surface. The UBS648's new centrally located digital keypad and tilt-out tray design makes accessing contents even easier.

#### FEATURES

- Tilt-out door for easy access
- Foam padded slide-out gun tray
- UL Listed ESL5-LP electronic lock with backlit and stealth mode keypad
- 18GA body & 7GA door steel construction
- 4-point locking bar
- 4 mounting holes on the top and bottom of safe
- Side handles with cutouts to attach straps or security cables
- Mini flashlight with flashlight holder

Model	Outside Dimension H x W x D	Door Clearance H x W	Body Thickness	Interior Capacity	Weight	Lock Type
UBS648	6" x 48" x 14 $\frac{5}{8}$ "	13" x 44 $\frac{1}{2}$ "	$\frac{1}{16}$ "	1.50 cu. ft.	80 lbs.	ESL5LP

# Handgun Series



PS1210HD



PS1208EZ



HAS410

#### PS SERIES FEATURES

- Reliable fast access Simplex push button mechanical locking device.
- Welded and concealed continuous hinge
- Strong, pry-resistant locking bolt
- Locking mechanism protected by steel housing, impervious to punch attacks
- Heavy-duty chrome carrying handle
- Protective high density pluck foam-lined interior
- 4 pre-drilled bolt down holes
- Packaged for UPS/FedEx shipments.

#### HAS SERIES FEATURES

- Reliable fast access Simplex push button mechanical locking device.
- Strong, pry-resistant locking bolt
- Locking mechanism protected by steel housing, impervious to punch attacks
- Protective high density pluck foam-lined interior
- 4 anchor holes on the top and 4 anchor holes on the bottom
- Packaged for UPS/FedEx shipments.

Model	Outside Dimension H x W x D	Door Clearance H x W	Body Thickness	Interior Capacity	Weight	Lock Type
PS1210HD	10 $\frac{1}{4}$ " x 12 $\frac{1}{4}$ " x 4 $\frac{1}{4}$ "	9 $\frac{5}{8}$ " x 11 $\frac{5}{8}$ "	10GA	273 cu. in.	24 lbs.	Simplex Mechanical Push Button
PS1208EZ	8 $\frac{3}{8}$ " x 12 $\frac{1}{4}$ " x 4"	7 $\frac{3}{4}$ " x 11 $\frac{3}{4}$ "	14GA	222 cu. in.	11 lbs.	Simplex Mechanical Push Button
HAS410	12" x 10" x 4"	10 $\frac{1}{16}$ " x 7 $\frac{1}{4}$ "	10GA	172 cu. in.	20 lbs.	Simplex Mechanical Push Button

# Vault Door Series



## FEATURES:

- 2" thick door
- Made in the USA
- (10) 1½" chrome plated bolts (5 bolts on inswing doors)
- Adjustable frame to fit walls ranging from 4¾" to 9½" thick
- Only VD offered with a "poured" fire protection mixture (DryLight®) - American Security's proprietary seamless, lightweight, high performance fire barrier
- Safety lock release
- Spy-proof key-locking dial
- 1 year parts and labor warranty

## BF SERIES VAULT DOOR FEATURES:

- ½" steel plate on face of door providing a superior security barrier
- 1¾" of seamless DryLight® as fire protection

## BFQ SERIES VAULT DOOR FEATURES:

- ¼" steel plate on face of door providing a superior security barrier
- 1½" of seamless DryLight® as fire protection

## OPTIONAL FEATURES:

- Left or right swing door

## PANIC LOCK FEATURES:

- Standard with all VD models
- Allows the user to safely lock themselves inside, despite the lock combination being entered from the outside

VD8030BFQ / VD8036BFQ / VD8042BFQ

VD8030BF / VD8036BF / VD8042BF



## TEXTURED



## HARDWARE

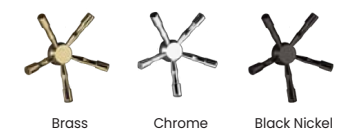

Model	Swing Type	Wall Opening H x W	Door Opening H x W	Weight	Lock Type
VD8030BFQ	Out-Swing	79½" x 29½"	77½" x 24¾"	650 lbs.	Key-Locking Spy-Proof Dial   Lock Spy-Proof Dial   ESL5   ESL10
VD8030BFQIS	In-Swing	79½" x 29½"	77" x 20¾"	634 lbs.	Key-Locking Spy-Proof Dial   Lock Spy-Proof Dial   ESL5   ESL10
VD8030BF	Out-Swing	79½" x 29½"	77½" x 24¾"	839 lbs.	Key-Locking Spy-Proof Dial   Lock Spy-Proof Dial   ESL5   ESL10
VD8030BFIS	In-Swing	79½" x 29½"	77" x 20¾"	816 lbs.	Key-Locking Spy-Proof Dial   Lock Spy-Proof Dial   ESL5   ESL10
VD8036BFQ	Out-Swing	79½" x 35½"	77½" x 31"	762 lbs.	Key-Locking Spy-Proof Dial   Lock Spy-Proof Dial   ESL5   ESL10
VD8036BFQIS	In-Swing	79½" x 35½"	77" x 26¼"	726 lbs.	Key-Locking Spy-Proof Dial   Lock Spy-Proof Dial   ESL5   ESL10
VD8036BF	Out-Swing	79½" x 35½"	77½" x 31"	989 lbs.	Key-Locking Spy-Proof Dial   Lock Spy-Proof Dial   ESL5   ESL10
VD8036BFIS	In-Swing	79½" x 35½"	77" x 26¼"	957 lbs.	Key-Locking Spy-Proof Dial   Lock Spy-Proof Dial   ESL5   ESL10
VD8042BF	Out-Swing	79½" x 41½"	77½" x 37"	1139 lbs.	Key-Locking Spy-Proof Dial   Lock Spy-Proof Dial   ESL5   ESL10
VD8042BFIS	In-Swing	79½" x 41½"	77" x 32¼"	1098 lbs.	Key-Locking Spy-Proof Dial   Lock Spy-Proof Dial   ESL5   ESL10
VD8042BFQ	Out-Swing	79½" x 41½"	77½" x 37"	874 lbs.	Key-Locking Spy-Proof Dial   Lock Spy-Proof Dial   ESL5   ESL10
VD8042BFQIS	In-Swing	79½" x 41½"	77" x 32¼"	818 lbs.	Key-Locking Spy-Proof Dial   Lock Spy-Proof Dial   ESL5   ESL10

# Stor-It Cabinets



## 2-DRAWER FEATURES

- Top drawer includes a 7 compartment ring organizer and a 6 compartment jewelry organizer
- Bottom drawer can be used for bulky items or converts to a file drawer

## 4-DRAWER FEATURES

- Top drawer features a 4 compartment ring organizer and a 5 compartment jewelry organizer.
- Drawer 2 features a 15 compartment ring organizer.
- Drawer 3 features a 5 compartment necklace organizer.
- Drawer 4 can be used for bulky items.

**Stor-It Cabinets will slide into the following safe models without modification:**

- BFX7250, BFII7250, BF1716, BF3416
- CE2518, CE3524, CE4524, CE5524, CE6528
- CF2518, CF3524, CF4524, CF5524, CF6528, CF7236
- CSC3018

**Stor-It Cabinets may be used with the following safe models, but require custom interior at time of purchase:**

- BFX7240, BFX6636, BFX6030, BFII7240, BFII6636, BFII6030

Model	Outside Dimension H x W x D	Weight Lbs.
2-Drawer	16 $\frac{5}{8}$ " x 15 $\frac{1}{8}$ " x 14 $\frac{3}{16}$ "	34
4-Drawer	16 $\frac{5}{8}$ " x 15 $\frac{1}{8}$ " x 14 $\frac{3}{16}$ "	39

# The Safe Cloak



## HIDE YOUR GUN SAFE IN PLAIN SIGHT!

Instantly disguise your gun safe with American Security's Safe Cloak. Available in 5 different sizes, the Safe Cloak fits over your gun safe to instantly disguise it as a wood cabinet. Strong magnets and a sewn-in PVC board at the top easily and securely hold the cloak in place. The thermal-transfer, four-color wood-cabinet print is so good, it will fool not only passersby, but guests as well.

Available in the following model sizes: 6024, 6030, 6636, 7240, 7250.

# Locks

For quick and easy entry, an electronic lock is the lock of choice. These locks are powered by batteries located in the keypad and allow you to change your combination anytime.



**ESL5**  
Available in Chrome and Black Nickel Finish



**ESL20**  
Available in Brass, Chrome and Black Nickel Finish



**ESL10**  
Available in Brass, Chrome and Black Nickel Finish



**ESL5LP**  
Available in Black



**KEY LOCKING FRONT READ DIAL**  
Key is used to lock dial in a fixed position and affords dual custody control. Manager has the combination, collector has the key. Both must be present to unlock the safe.



**FRONT READ DIAL**  
Safes equipped with Time Locks offer the capability of locking the safe for a pre-selected period of time. Time periods range from one hour to 144 hours (6 full days).



**KEYLOCKING SPYPROOF DIAL**  
Restricts unauthorized viewing while dialing the combination, as well as providing dual custody control.



**U.L. LISTED DUAL NOSE KEY LOCK**  
Dual control safe deposit lock requires two different keys to open safe.



**U.L. LISTED HIGH SECURITY KEY LOCK**  
European style nine-lever changeable key lock offers exceptional security features for use on inner locker or outer safe doors.



**SPYPROOF DIAL**  
Restricts unauthorized viewing while dialing combination. Also available with key locking feature.

# Other Options



**.50 CALIBER HANDLE**  
Available in Black Nickel BFX, BFII & NF Gun Safes only.



**DEHUMIDIFIER ROD**  
Keeps your guns safe from the threat of rust, pitting and moisture damage. Electrical access required.



**PISTOL RACK**  
This four-gun rack is ideal for organizing pistols inside your safe.

**Available While Supplies Lasts!**



**JEWELRY DRAWER**  
Velvet lined jewelry drawer that can be installed on top or underneath any shelf larger than 10" wide and 13<sup>13</sup>/<sub>16</sub> deep.



**POWER STRIP**  
3-Outlet Power Strip with two USB ports and removable cord.



**36" LED LIGHT KIT**  
Has (2) 36" light strips with high-intensity white LED lights and a motion sensor that automatically turns the lights on when motion is detected. The lights turn off 30 seconds after motion has stopped. This light kit can be installed on any American Security safe and is also available as a retrofit kit.



**8" COMPACT LED LIGHT KIT**  
Provides greater visibility inside smaller American Security® safes. Features (2) 8" light strips with high-intensity white LED lights and a motion sensor that automatically turns the lights on when motion is detected. The lights turn off 30 seconds after motion has stopped. This light kit can be installed on any American Security safe. Includes battery pack. Retrofit Only.

## PREMIUM UPGRADE PACKAGE FOR BFX, NF AND SF SAFES

When you choose to upgrade your American Security BFX, NF or SF Series with a Premium Package, we'll add on some of our most popular options, including the Dehumidifier Rod, a Jewelry Drawer, an LED light kit\*, and a 3-outlet power strip with USB.

\*LED light kit standard on BFII, BFX, and RF gun safes

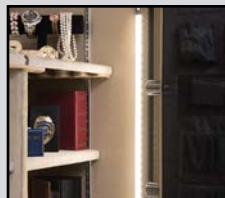

# Gun Safes at a Glance

Model	Exterior Dimensions	Gun Capacity	Weight Lbs.	PDO Included	Bolts	Bolt Dia.	Relocker
<b>RF SERIES</b>							
<b>RF703620X6</b>	76" x 42" x 29¼"	12-12-12-24-36+2 Gun or 58 + 2 Gun	4,578	Yes	10	1½"	Yes
<b>RF582820X6</b>	64" x 34" x 29¼"	12-12-24 + 2 Gun	3,455	Yes	10	1½"	Yes
<b>RF6528</b>	72" x 35" x 29¼"	12-12-24 + 2 Gun	3,418	Yes	10	1½"	Yes
<b>BFII SERIES</b>							
<b>BFII7250</b>	71¼" x 50" x 28"	14-14-14-28-42 + 2 Gun or 73 + 2 Gun	2,438	Yes	10	1½"	Yes
<b>BFII7240</b>	71¼" x 40" x 26"	12-12-12-24-36 + 2 Gun or 58 + 2 Gun	1,991	Yes	10	1½"	Yes
<b>BFII6636</b>	65¼" x 36" x 26"	12-12-24 + 2 Gun	1,716	Yes	10	1½"	Yes
<b>BFII6030</b>	59¼" x 30" x 26"	11-11-22 + 2 Gun	1,395	Yes	10	1½"	Yes
<b>BFII6032</b>	59¼" x 30" x 21"	9-9-18 + 2 Gun	1,244	Yes	10	1½"	Yes
<b>BFII6024</b>	59¼" x 24" x 21"	8-8-16 Gun + 1 Gun	1,067	Yes	10	1½"	Yes
<b>BFX SERIES</b>							
<b>BFX7250</b>	71¼" x 50" x 28"	14-14-14-28-42 + 2 Gun or 73 + 2 Gun	1,789	Yes	16	1½"	Yes
<b>BFX7240</b>	71¼" x 40" x 26"	12-12-12-24-36 + 2 Gun or 58 + 2 Gun	1,585	Yes	16	1½"	Yes
<b>BFX6636</b>	65¼" x 36" x 26"	12-12-24 + 2 Gun	1,319	Yes	16	1½"	Yes
<b>BFX6030</b>	59¼" x 30" x 26"	11-11-22 + 2 Gun	1,036	Yes	14	1½"	Yes
<b>BFX6032</b>	59¼" x 30" x 21"	9-9-18 + 2 Gun	913	Yes	14	1½"	Yes
<b>BFX6024</b>	59¼" x 24" x 21"	8-8-16 Gun + 1 Gun	720	Yes	10	1½"	Yes
<b>NF SERIES</b>							
<b>NF6036</b>	59" x 36" x 26"	17-17-34 + 2 Gun	977	Yes	14	1½"	Yes
<b>NF6030</b>	59" x 30" x 26"	14-14-28 + 2 Gun	788	Yes	14	1½"	Yes
<b>NF6032</b>	59" x 30" x 21"	9-9-18 + 2 Gun	761	Yes	14	1½"	Yes
<b>NF5924</b>	59" x 24" x 18"	8-8-16 Gun + 1 Gun	600	Yes	14	1½"	Yes
<b>SF SERIES</b>							
<b>SF7240</b>	72" x 40" x 26"	15-15-15-30-45 + 2 Gun	1,086	Yes	14	1¼"	Yes
<b>SF6036</b>	59" x 36" x 26"	17-17-34 + 2 Gun	840	Yes	14	1¼"	Yes
<b>SF6030</b>	59" x 30" x 26"	15-15-30 + 2 Gun	748	Yes	14	1¼"	Yes
<b>SF6032</b>	59" x 30" x 21"	9-9-18 + 2 Gun	662	Yes	14	1¼"	Yes
<b>TF SERIES</b>							
<b>TF5924</b>	59" x 24" x 18"	8-8-16 Gun + 1 Gun	388	Yes	14	1¼"	Yes
<b>TF5517</b>	55¼" x 17¾" x 16"	11 Gun	286	Yes	8	1"	Yes

Dimensions listed are exterior dimensions. Add 2<sup>3</sup>/<sub>4</sub>" on all BF and NF safes and 2" on all other safes to overall depth for lock and handle.

# Gun Safes at a Glance

	Warranty	U.L. Listing	Thickness		Fire Rating	Standard Lock	Handle	Standard Interior
			Door	Body				
	Lifetime Theft & Fire	TL30-X6	6	3"	120 min / 1800°	Spy-Proof, Key-Locking Dial, ESL5, ESL10	5-Spoke	Tan Pin-Dot
	Lifetime Theft & Fire	TL30-X6	6	3"	120 min / 1800°	Spy-Proof, Key-Locking Dial, ESL5, ESL10	5-Spoke	Tan Pin-Dot
	Lifetime Theft & Fire	TL30	6	3"	120 min / 1800°	Spy-Proof, Key-Locking Dial, ESL5, ESL10	5-Spoke	Tan Pin-Dot
	5-year parts and labor warranty when purchased with a factory installed American Security lock.  Special lifetime warranty for damage from burglary attempts and fire.	RSC Level II	4 $\frac{3}{8}$ " / ½"	2 $\frac{1}{4}$ "	ETL 120 min / 1200°	Spy-Proof, Key-Locking Dial, ESL5, ESL10	5-Spoke	Tan Pin-Dot
		RSC Level II	4 $\frac{3}{8}$ " / ½"	2 $\frac{1}{4}$ "	ETL 120 min / 1200°	Spy-Proof, Key-Locking Dial, ESL5, ESL10	5-Spoke	Tan Pin-Dot
		RSC Level II	4 $\frac{3}{8}$ " / ½"	2 $\frac{1}{4}$ "	ETL 120 min / 1200°	Spy-Proof, Key-Locking Dial, ESL5, ESL10	5-Spoke	Tan Pin-Dot
		RSC Level II	4 $\frac{3}{8}$ " / ½"	2 $\frac{1}{4}$ "	ETL 120 min / 1200°	Spy-Proof, Key-Locking Dial, ESL5, ESL10	5-Spoke	Tan Pin-Dot
		RSC Level II	4 $\frac{3}{8}$ " / ½"	2 $\frac{1}{4}$ "	ETL 120 min / 1200°	Spy-Proof, Key-Locking Dial, ESL5, ESL10	5-Spoke	Tan Pin-Dot
		RSC Level II	4 $\frac{3}{8}$ " / ½"	2 $\frac{1}{4}$ "	ETL 120 min / 1200°	Spy-Proof, Key-Locking Dial, ESL5, ESL10	L-Handle	Tan Pin-Dot
	5-year parts and labor warranty when purchased with a factory installed American Security lock.  Special lifetime warranty for damage from burglary attempts and fire.	RSC Level I	4 $\frac{5}{8}$ " / ¾"	2"	ETL 120 min / 1200°	Spy-Proof, Key-Locking Dial, ESL5, ESL10	5-Spoke	Tan Pin-Dot
		RSC Level I	4 $\frac{3}{8}$ " / ½"	2"	ETL 120 min / 1200°	Spy-Proof, Key-Locking Dial, ESL5, ESL10	5-Spoke	Tan Pin-Dot
		RSC Level I	4 $\frac{3}{8}$ " / ½"	2"	ETL 120 min / 1200°	Spy-Proof, Key-Locking Dial, ESL5, ESL10	5-Spoke	Tan Pin-Dot
		RSC Level I	4 $\frac{3}{8}$ " / ½"	2"	ETL 120 min / 1200°	Spy-Proof, Key-Locking Dial, ESL5, ESL10	5-Spoke	Tan Pin-Dot
		RSC Level I	4 $\frac{3}{8}$ " / ½"	2"	ETL 120 min / 1200°	Spy-Proof, Key-Locking Dial, ESL5, ESL10	5-Spoke	Tan Pin-Dot
		RSC Level I	4 $\frac{5}{8}$ " / ¾"	2"	ETL 120 min / 1200°	Spy-Proof, Key-Locking Dial, ESL5, ESL10	3-Spoke	Tan Pin-Dot
	Lifetime Theft & Fire	RSC Level I	4 $\frac{1}{4}$ " / ¼"	11GA	ETL 90 min / 1200°	ESL10 Electronic Lock	5-Spoke	Gray Fabric
	Lifetime Theft & Fire	RSC Level I	4 $\frac{1}{4}$ " / ¼"	11GA	ETL 90 min / 1200°	ESL10 Electronic Lock	5-Spoke	Gray Fabric
	Lifetime Theft & Fire	RSC Level I	4 $\frac{1}{4}$ " / ¼"	11GA	ETL 90 min / 1200°	ESL10 Electronic Lock	5-Spoke	Gray Fabric
	Lifetime Theft & Fire	RSC Level I	4 $\frac{1}{4}$ " / ¼"	11GA	ETL 90 min / 1200°	ESL10 Electronic Lock	5-Spoke	Gray Fabric
	Lifetime Theft & Fire	B-Rate	3 $\frac{5}{8}$ " / ¾"	12GA	ETL 60 min / 1200°	ESL5 Electronic Lock	3-Spoke	Gray Fabric
	Lifetime Theft & Fire	B-Rate	3 $\frac{5}{8}$ " / ¾"	12GA	ETL 60 min / 1200°	ESL5 Electronic Lock	3-Spoke	Gray Fabric
	Lifetime Theft & Fire	B-Rate	3 $\frac{5}{8}$ " / ¾"	12GA	ETL 60 min / 1200°	ESL5 Electronic Lock	3-Spoke	Gray Fabric
	Lifetime Theft & Fire	B-Rate	3 $\frac{5}{8}$ " / ¾"	12GA	ETL 60 min / 1200°	ESL5 Electronic Lock	3-Spoke	Gray Fabric
	Lifetime Theft & Fire	B-Rate	3 $\frac{5}{8}$ " / ¾"	14GA	30 min / 1200°	ESL5 Electronic Lock	3-Spoke	Gray Fabric
	Lifetime Theft & Fire	B-Rate	3 $\frac{1}{4}$ " / ¾"	14GA	30 min / 1200°	ESL5 Electronic Lock	"L" Handle	Gray Fabric



At American Security, we have been dedicated to providing quality security solutions to our customers since our establishment in 1946.

Additionally, American Security entered the Smart Safe market 10 years ago with CashWizard, securing two more patents for our Smart Safe technology. The CashWizard Smart Safe is the highest security depository safe of its kind on the market today and provides ultimate visibility into daily cash transactions via integrated cloud-based software that gives treasury and other management suites the ability to remotely manage money from anywhere in the world, 24 hours a day, 7 days a week.

At American Security, we believe that innovation is not just about creating new products but also improving existing ones. We continuously update our products to keep up with the latest technology and security standards, ensuring that our customers have the best possible experience with our products.

Our humble beginnings started with little more than a welder, lathe, and a desire to build strong safes. As we've grown, we've expanded our offerings to meet the changing needs of our customers. Through dedication and hard work, we have become a leading name in the security industry, providing a wide range of products and services, including our CashWizard Smart Safes.

Over the years, we've had the privilege to work with a diverse range of clients across various industries and have been recognized for our commitment to quality and excellence. At American Security, our core values guide us in everything we do. We are committed to providing the highest level of security solutions to our customers and continuously strive to innovate and improve our offerings.



*American Security reserves the right to update products as necessary*